

**i**move<sup>F</sup>



VERSION 05 | 2013

<b>Inhaltsverzeichnis</b>	<b>Kapitel</b>	<b>Contents</b>	<b>Chapter</b>
<b>Oberflächen - Farben</b>	<b>01.01 - 01.05</b>	<b>surfaces - colours</b>	<b>01.01 - 01.05</b>
<b>Erläuterungen</b>	<b>02.01 - 02.03</b>	<b>explanations</b>	<b>02.01 - 02.03</b>
<b>Arbeitsische</b>	<b>03.01 - 03.04</b>	<b>work stations</b>	<b>03.01 - 03.04</b>
Tische mit zwei Rahmenwangen		desks with two rectangular side parts	
Tische für Korpusunterbau		desks for lowboards, pedestals	
<b>Unterbauten</b>	<b>04.01 - 04.03</b>	<b>carcass</b>	<b>04.01 - 04.03</b>
Lowboards		lowboards	
Technikcontainer		pedestals for files and hardware	
<b>Besprechungstische</b>	<b>05.01 - 05.03</b>	<b>conference desks</b>	<b>05.01 - 05.03</b>
<b>Kabelmanagement</b>	<b>06.01 - 06.02</b>	<b>cable management</b>	<b>06.01 - 06.02</b>
<b>Zubehör</b>	<b>07.01 - 07.02</b>	<b>accessories</b>	<b>07.01 - 07.02</b>
Monitorarme		monitor arms	
CPU-Halter		CPU stand	
Aufsatzwände		table top screens	

**Artikelbezeichnung und Farbkennung**

Zur eindeutigen Bestimmung eines Artikels ist die Angabe  
• der Artikelbezeichnung und  
• der Farbkennung erforderlich.

In Artikelbezeichnungen, die Varianten enthalten, müssen eine oder mehrere Angaben, z. B. zu Oberfläche oder Plattennummer, eingesetzt werden. Die einzusetzenden Zeichen entsprechen der Anzahl der Sternchen (\*). Optionen werden durch Ergänzungen zur Artikelbezeichnung gekennzeichnet. Zum Teil muss für die Optionen ein Aufpreis addiert werden.

Die Anzahl der notwendigen Farbangaben variiert von Artikel zu Artikel. Die Reihenfolge ist durch Nummerierung definiert.

<b>IMF2TR1</b>	<b>-16</b>	<b>-H2</b>	<b>-SM</b>	<b>-FO4</b>	<b>055/057/049</b>
rechteckig, 90 cm tief					
<b>Breite:</b> 160 cm					
<b>Verstellart:</b> Handverstellung					
<b>Variante:</b> Spanplatte, Melamin					
<b>Option:</b> Rahmenwange hochglanzchrom					
<b>Notwendige Farbangaben:</b>					
1. Gestell: kristallweiß struktur					
2. Rahmenwange: hochglanzchrom (Option)					
3. Platte: kristallweiß					

**Article reference and colour code**

For the exact article definition the following details are required:  
• the article reference and  
• the colour code

Articles which are available in different variants have to be completed with one or more details such as the surface or the desk number. The number of stars (\*) shows the number of symbols which have to be indicated.

Options will be added to the article reference and the up-charge for some options has to be added to the basic article price.

The number of required colour codes is different for each article. The sequence is defined by the numbering.

<b>IMF2TR1</b>	<b>-16</b>	<b>-H2</b>	<b>-SM</b>	<b>-FO4</b>	<b>055/057/049</b>
rectangular, 90 cm deep					
<b>width:</b> 160 cm					
<b>adjustment:</b> by hand					
<b>variant:</b> chipboard, melamine					
<b>option:</b> frame mirror finish chrome					
<b>necessary colour detail:</b>					
1. column, cross rail: crystal white structure					
2. frame: mirror finish (option)					
3. top: crystal white					

**Bei diesen Artikeln sind unbedingt Farbangaben bei der Bestellung notwendig:**

Colours of the following articles must be indicated in the order:

Artikel	article	Farbcode / colour code
Arbeitsstische	work stations	
- Gestell*	- frame*	- 021, 022, 023, 029, 055, 056, 068, 075 (Option -FO2)**
- Rahmenwange*	- rectangular side part*	- 021, 022, 023, 029, 055, 056, 068, 057 (Option -FO4)***
- Platte	- top	- 011, 024, 026, 041, 042, 049, 051, 052, 080, 081, 082, 111, 122, 131, 132, 141, 161, 171, 181, 191
Besprechungstische	conference desks	
- Gestell*	- frame*	- 021, 022, 023, 029, 055, 056, 068, 075 (Option -FO2)**
- Fußplatte*	- foot plate*	- 021, 022, 023, 029, 055, 068, 077 (Option -FO5)***
- Platte	- top	- 011, 024, 026, 041, 042, 049, 051, 052, 080, 081, 082, 111, 122, 131, 132, 141, 161, 171, 181, 191
Kabeldurchlass aus Metall	cable outlet made of metal	- 057, 059
Lowboards	lowboards	
- Korpus	- carcass	- 011, 014, 024, 026, 041, 042, 049, 051, 052, 072, 080, 081, 082
- Front	- front	- 011, 014, 024, 026, 041, 042, 049, 051, 052, 070, 071, 072, 080, 081, 082, 111, 122, 131, 132, 141, 161, 171, 181, 191
- Abdeckplatte Echtholz (Option)	- top real wood (option)	- 111, 122, 131, 132, 141, 161, 171, 181, 191
- Kabelkette	- cable chain	- 044, 049
- Kabelkettendurchlass	- cable chain outlet	- 021, 022, 023, 029, 055, 056, 068
Technikcontainer	pedestals	
- Korpus	- carcass	- 011, 014, 024, 026, 041, 042, 049, 051, 052, 072, 080, 081, 082
- Blenden/Abdeckplatte	- blinds/top	- 011, 014, 024, 026, 041, 042, 049, 051, 052, 072, 080, 081, 082, 070 (Option -FO1), 071 (Option -FO1), 111, 122, 131, 132, 141, 161, 171, 181, 191
- Kabelkette	- cable chain	- 044, 049
- Kabelkettendurchlass	- cable chain outlet	- 021, 022, 023, 029, 055, 056, 068
Kabelwanne*	cable tray*	- 021, 022, 023, 029, 055, 056, 068
Kabelkette mit Standfuß	cable chain with foot	
- Kabelkette	- cable chain	- 044, 049
- Standfuß*	- foot*	- 021, 022, 023, 029, 055, 056, 068
Kabelschlange	cable chain	- 014, 045
CPU-Halter*	CPU stand*	- 021, 022, 023, 029, 055, 056, 068
Aufsatzwände	table top screens	
- Stoffbezug	- fabric	- siehe Prospekt Oberflächen, see brochure surfaces

**Diese Artikel haben immer folgende Farbausführung:**

These articles are available only with the following colours:

Artikel	article	Farbcode / colour code
Kabelschacht, Facheinteilung für Organisations Schubfächer (Sideboard)	cable duct, drawer partitions (side-board)	silber metallic / silver metallic
Abdeckstopfen f. Organisationsbohrungen	cover for organisation holes	Edelstahl / stainless steel
Monitorarm	monitor arm	silber metallic / silver metallic
Zubehör für Aufsatzwände	accessories for table top screens	silber struktur / silver structure
Griff K	handle type K	matt/verchromt / matt chrom-plated
Griff M bzw. Griff N	handle type M or N	Aluminium farblos eloxiert aluminium clear anodised

**Farbkürzel / colour codes**

011	lichtgrau	light grey	070	orangerot	orange red
014	schwarz	black	071	apfelgrün	apple green
021	schwarz struktur	black structure	072	graphit	graphite
022	silber struktur	silver structure	075	Aluminium gebürstet	aluminium brushed
023	lichtgrau struktur	light grey structure		farblos eloxiert	clear anodised
024	Buche Dekor	beech decor	077	Stahl verchromt	chrome-plated steel
026	Ahorn Dekor	maple decor	080	Pflaume Dekor	plum decor
029	silber metallic	silver metallic	081	Kirschbaum Dekor	cherry tree decor
041	weißaluminium	aluminium white	082	Olive dunkel Dekor	olive wood decor
042	Weißbuche Dekor	light beech decor	111	Echtholz Buche	beech veneer
044	alugrau	aluminium grey	122	Echtholz Esche schwarz offenporig	ash tree open-pored veneer
049	kristallweiß	crystal white	131	Echtholz Ahorn europäisch	European maple veneer
051	Balearen Eiche Dekor	Balearic oak decor	132	Echtholz Ahorn kanadisch	Canadian maple veneer
052	Zebrano Dekor	zebrano decor	141	Echtholz Schweizer Birnbaum	Swiss pearwood veneer
055	kristallweiß struktur	crystal white structure	161	Echtholz Nussbaum	walnut veneer
056	helium	helium	171	Echtholz Zebrano	zebrano veneer
057	hochglanzchrom	mirror finish	181	Echtholz Eiche	oak veneer
059	matt verchromt	matt chrome-plated	191	Echtholz Kirschbaum	cherry veneer
068	graphit struktur	graphite structure			

**Wichtiger Hinweis:**

Holz ist ein gewachsener Werkstoff. Kein Stamm gleicht dem anderen. Die einzelnen Stämme unterscheiden sich in Maserung und Farbe. Aber auch innerhalb eines Stammes treten Struktur- und Tonunterschiede auf. Unter Lichteinwirkung und durch extrem feuchtes oder extrem trockenes Klima kann sich die Holzfarbe ändern. **Unterschiede, Unregelmäßigkeiten und Veränderungen, die aufgrund der natürlichen Beschaffenheit des Holzes auftreten, sind kein Grund zur Beanstandung.** Die Furniere werden sorgfältig und kommissionsweise ausgewählt. Soweit möglich verwenden wir für einen Auftrag Furnier aus einem Stamm. Dadurch werden die Unterschiede in Struktur und Färbung so gering wie möglich gehalten. Bei Nachlieferungen sind Unterschiede in Struktur und Färbung kein Grund zur Beanstandung.

**Important note:**

Wood is a grown material. No trunk of a tree is alike the other. The single trunks are different in grain and colour. Also within a trunk there are differences in structure and tone. When exposed to light radiation and in an extremely humid or extremely dry climate the wood colour can change. **Differences and changes caused by the natural quality of the wood are no reason for complaint.** The veneer will be chosen carefully and separately for each commission. As far as possible we use veneer of the same trunk for one order. This helps to keep differences in structure and colour as low as possible. Differences in structure and colour are no reason for complaint in subsequent deliveries.

\* weitere RAL-Farben auf Anfrage erhältlich, ohne Aufpreis / additional RAL-colours available upon request, without up-charge









\*\* Farbausführung 075 für Arbeitsstische und Besprechungstische, höhenverstellbar (optional gegen Aufpreis -FO2):

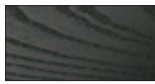





Säulenprofil Aluminium gebürstet farblos eloxiert 075, Gestell silber metallic 029  
colour 075 for work stations and conference desks, height adjustable (option with up-charge -FO2):  
columns aluminium brushed clear anodised 075, frame silver metallic 029

\*\*\* Farbausführung 057 (Option -FO4): Die Fußplatten der Anket- und Besprechungstische werden dazu passend in 077 (-FO5) angeboten  
colour 057 (option -FO4): The foot plates of add-on and conference desks are offered in matching colour 077 (-FO5)



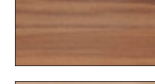
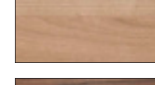
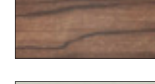
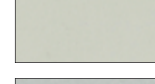
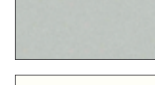

**Platte (Furnier Echtholz)**  
Top (veneer surface real wood)

**Platte (Melamin)**  
Top (melamine surface)

	111 Echtholz Buche beech veneer
	122 Echtholz Esche schwarz offenporig ash tree open-pored veneer
	131 Echtholz Ahorn europäisch European maple veneer
	132 Echtholz Ahorn kanadisch Canadian maple veneer
	141 Echtholz Schweizer Birnbaum Swiss pearwood veneer
	161 Echtholz Nussbaum walnut veneer
	171 Echtholz Zebrano zebrano veneer
	181 Echtholz Eiche oak veneer
	191 Echtholz Kirschbaum cherry veneer

	024 Buche Dekor beech decor
	026 Ahorn Dekor maple decor
	042 Weißbuche Dekor light beech decor
	051 Balearen Eiche Dekor Balearic oak decor
	052 Zebrano Dekor zebrano decor
	080 Pflaume Dekor plum decor
	081 Kirschbaum Dekor cherry tree decor
	082 Olive dunkel Dekor olive wood decor
	011 lichtgrau light grey
	041 weißaluminium aluminium white
	049 kristallweiß crystal white

**Arbeitsstische: Gestell\*, Rahmenwange\***  
Work stations: frame\*, rectangular side part\*

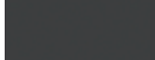
	021 schwarz struktur black structure
	022 silber struktur silver structure
	023 lichtgrau struktur light grey structure
	029 silber metallic silver metallic
	055 kristallweiß struktur crystal white structure
	056 helium helium
	068 graphit struktur graphite structure

**zusätzliche Option -FO2**  
additional option -FO2



Säulen Aluminium gebürstet farblos eloxiert 075  
Gestell silber metallic 029  
columns aluminium brushed clear anodised 075  
frame silver metallic 029



**zusätzliche Option -FO4 für Rahmenwange**  
additional option -FO4 for rectangular side part



057  
hochglanzchrom  
mirror finish

Die Fußplatten der Annett- und Besprechungstische werden dazu passend in 077 Stahl verchromt (-FO5) angeboten  
The foot plates of add-on and conference desks are offered in matching colour 077 (-FO5)

**Besprechungstische: Gestell\***  
Conference desks: frame\*

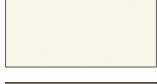
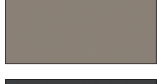
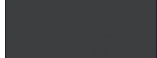
	021 schwarz struktur black structure
	022 silber struktur silver structure
	023 lichtgrau struktur light grey structure
	029 silber metallic silver metallic
	055 kristallweiß struktur crystal white structure
	056 helium helium
	068 graphit struktur graphite structure

**zusätzliche Option -FO2 für Besprechungstisch höhenverstellbar**  
additional option -FO2 for conference desks height adjustable

	Säulen Aluminium gebürstet farblos eloxiert 075 Gestell silber metallic 029 columns aluminium brushed clear anodised 075 frame silver metallic 029
-------------------------------------------------------------------------------------	-------------------------------------------------------------------------------------------------------------------------------------------------------------

**Besprechungstische: Fußplatte\***  
Conference desks: foot plate\*







	021 schwarz struktur black structure
	022 silber struktur silver structure
	023 lichtgrau struktur light grey structure
	029 silber metallic silver metallic
	055 kristallweiß struktur crystal white structure
	068 graphit struktur graphite structure

**zusätzliche Option -FO5 für Fußplatten**  
additional option -FO5 for foot plates

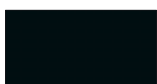
	077 Stahl verchromt chrome-plated steel
-------------------------------------------------------------------------------------	-----------------------------------------------

passend zu Rahmenwange der Arbeitstische 057 hochglanzchrom (-FO4)  
matching with rectangular side part of work stations 057 mirror finish (-FO4)







**Kabelwanne\*, CPU-Halter\***  
Cable tray\*, CPU stand\*

	021 schwarz struktur black structure		055 kristallweiß struktur crystal white structure
	022 silber struktur silver structure		056 helium helium
	023 lichtgrau struktur light grey structure		068 graphit struktur graphite structure
	029 silber metallic silver metallic		

Farbabweichungen zu den Originaloberflächen sind möglich / Colours may vary from actual material

**Kabelkette mit Standfuß**  
Cable chain with foot

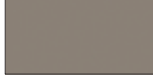

**Standfuß\*/foot\***

	021 schwarz struktur black structure
	022 silber struktur silver structure
	023 lichtgrau struktur light grey structure
	029 silber metallic silver metallic
	055 kristallweiß struktur crystal white structure
	056 helium helium
	068 graphit struktur graphite structure



**Kabelkette / cable chain**

	044 alugrau aluminium grey
	049 kristallweiß crystal white



**Kabeldurchlass aus Metall**  
Cable outlet made of metal

	057 hochglanzchrom mirror finish
	059 matt verchromt matt chrome-plated

**Lowboard, Technikcontainer: Kabelkettendurchlass**  
Lowboard, pedestal: cable chain outlet

	021 schwarz struktur black structure
	022 silber struktur silver structure
	023 lichtgrau struktur light grey structure
	029 silber metallic silver metallic
	055 kristallweiß struktur crystal white structure
	056 helium helium
	068 graphit struktur graphite structure

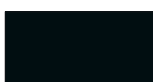







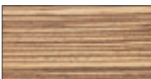

**Kabelschlange**  
Cable chain

	014 schwarz black
	045 transluzent translucent

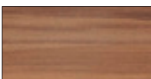

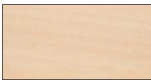
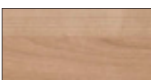





**Lowboard, Technikcontainer: Kabelkette**  
Lowboard, pedestal: cable chain

	044 alugrau aluminium grey
	055 kristallweiß struktur crystal white structure

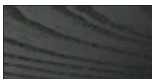
**Lowboard: Korpus, Front; Technikcontainer: Korpus, Blenden/Abdeckplatte (Melamin)**  
Lowboard: carcass, front; pedestal: carcass,blinds/top (melamine surface)

	011 lichtgrau light grey		024 Buche Dekor beech decor		052 Zebrano Dekor zebrano decor
	014 schwarz black		026 Ahorn Dekor maple decor		080 Pflaume Dekor plum decor
	041 weißaluminium aluminium white		042 Weißbuche Dekor light beech decor		081 Kirschbaum Dekor cherry tree decor
	049 kristallweiß crystal white		051 Balearen Eiche Dekor Balearic oak decor		082 Olive dunkel Dekor olive wood decor
	072 graphit graphite				

**Lowboard: Front, Abdeckplatte; Technikcontainer: Blenden/Abdeckplatte (Furnier Echtholz)**  
Lowboard: front, top; pedestals: blinds/top (veneer surface real wood)

	111 Echtholz Buche beech veneer		161 Echtholz Nussbaum walnut veneer
	122 Echtholz Esche schwarz offenporig ash tree open-pored veneer		171 Echtholz Zebrano zebrano veneer
	131 Echtholz Ahorn europäisch European maple veneer		181 Echtholz Eiche oak veneer
	132 Echtholz Ahorn kanadisch Canadian maple veneer		191 Echtholz Kirschbaum cherry veneer
	141 Echtholz Schweizer Birnbaum Swiss pearwood veneer		

**Lowboard: Front; Technikcontainer: Blenden/Oberboden (Lack)**  
Lowboard: front; pedestal: blinds/top (lacquer)

	070 orangerot orange red
	071 apfelgrün apple green





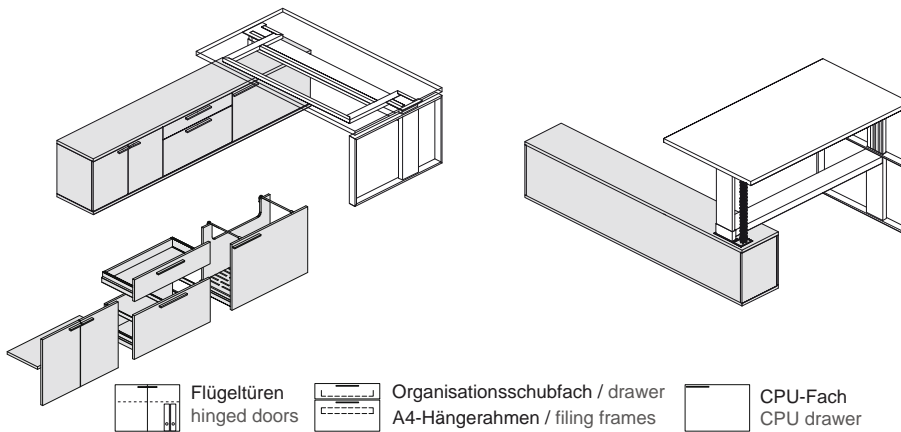
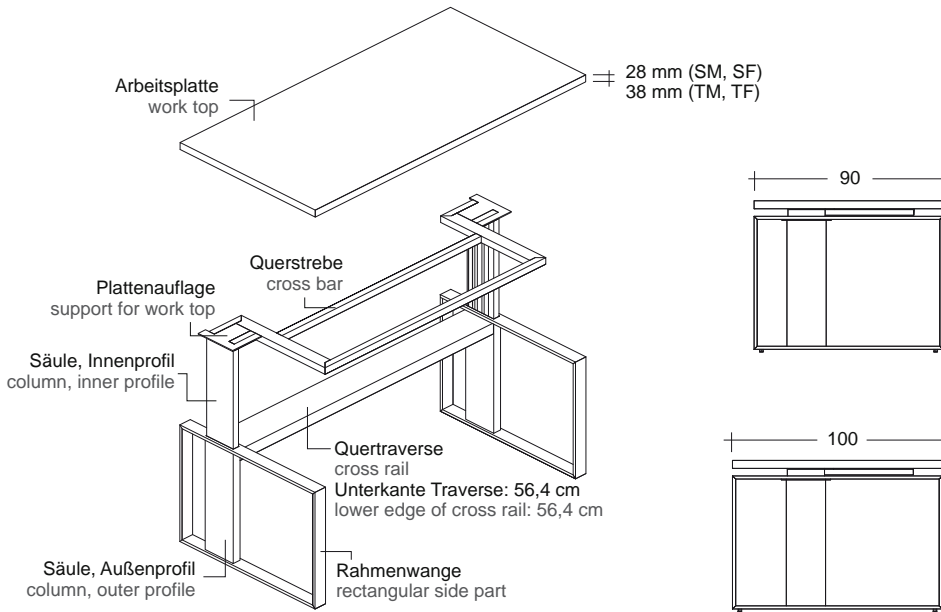

Arbeitstische mit **Lowboard**, 170 oder 250 cm breit, inkl. Kabelkette.  
CPU-Fach für Rechner max.  
32,8 cm breit, 45 cm hoch, 64,6 cm tief

Work stations with **lowboard**, 170 or 250 cm wide, with cable chain.  
CPU drawer for computers max.  
32,8 cm wide, 45 cm high, 64,6 cm deep.

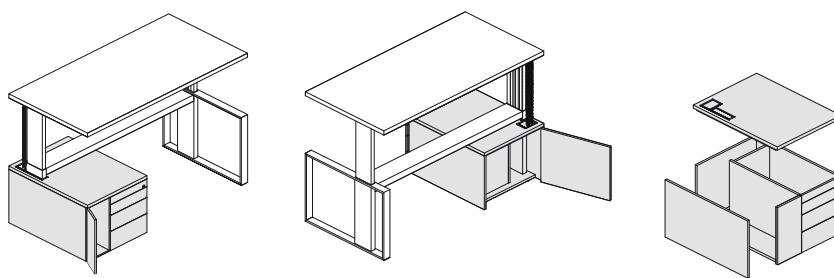

Arbeitstische mit **Technikcontainer**, inkl. Kabelkette.  
CPU-Fach für Rechner max.  
21 cm breit, 46 cm hoch, 53 cm tief

Work stations with **pedestals for files and hardware**, with cable chain.  
CPU drawer for computers max.  
21 cm wide, 46 cm high, 53 cm deep.

Die Arbeitsplatten für Tische mit Korpusunterbauten sind 3 cm breiter als die Standardmaße, um einen bündigen Abschluss mit dem Korpus zu gewährleisten.

The work tops for desks with a lowboard or pedestal are 3 cm wider than the standard tops in order to be flush with the carcass.

Kabelmanagement

cable management

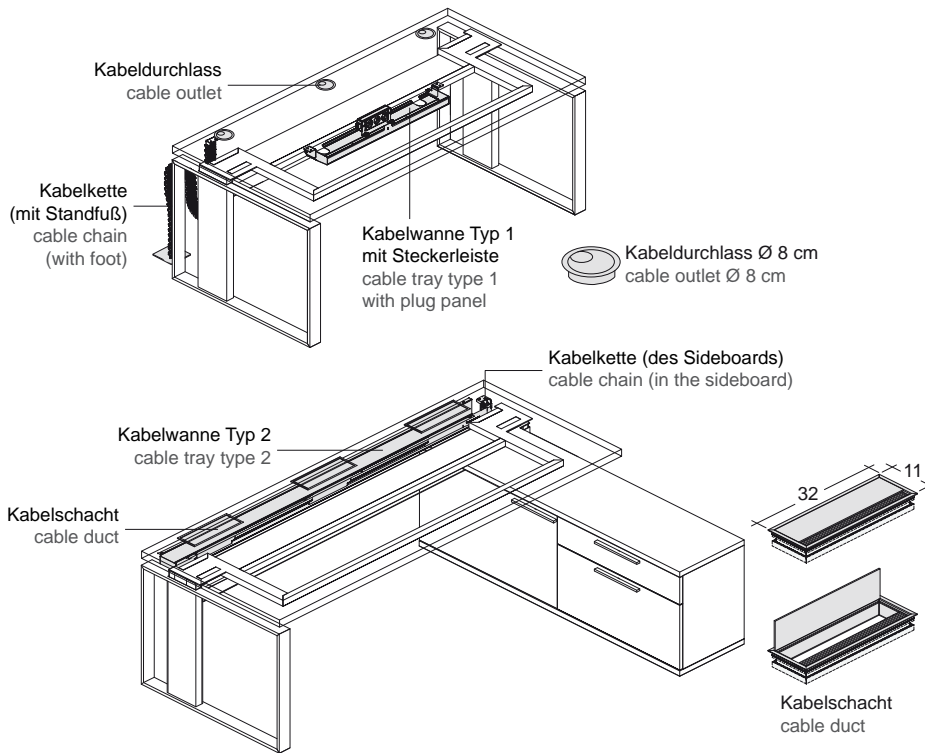

**Horizontale Kabelführung:**

- Kabeldurchlässe, Ø 8 cm, aus Metall, Positionen einzeln wählbar
- Kabelwanne Typ 1, 80 cm breit
- Kabelwanne Typ 2, gesamte Tischbreite
- Kabelschacht - **nur sinnvoll in Verbindung mit Kabelwanne Typ 2!**
- Kabelbügel, sinnvoll in Verbindung mit Kabelwanne Typ 1

**Vertikale Kabelführung:**

- Kabelkette mit Standfuß

**Weitere Option:**

- sinnvolle Anzahl von Organisationsbohrungen an der Hinterkante der Arbeitsplatte zur Aufnahme von Monitorarm oder Aufsatzwand bzw. zur Verschraubung von handelsüblichem Zubehör

**horizontal cabling:**

- cable outlets, Ø 8 cm, made of metal, positions can be chosen individually
- cable tray type 1, 80 cm wide
- cable tray type 2, entire width of desk
- cable duct - **only useful in combination with the cable tray type 2**
- cable bow, useful in combination with cable tray type 1

**vertical cabling**

- cable chain with foot

**further option:**

- useful number of organisation holes on the rear edge of the work top for the reception of monitor arm or partition wall as well as for the fixing of customary accessories.

**Kabelschächte, Turnboxen und weiteres Zubehör siehe separate Preisliste "Systemverkabelung"!**  
Cable ducts, turnboxes and further accessories see separate price list "Electrical Accessories"!

Höhenverstellung

height adjustment

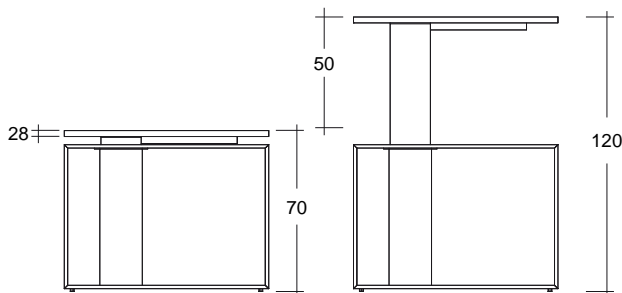

**Manuelle Verstellung H2**

- mit Gewichtsausgleich zur Abstimmung auf variable Tischlasten
- 3 Gewichtsklassen: 0 - 40, 20 - 60, 40 - 80 kg
- stufenlose Arretierung, bis 120 kg belastbar

**Motorverstellung M1**

- im Gestell integrierter, leise laufender Elektromotor
- Verstellgeschwindigkeit: ca. 70 mm/s
- Geräusentwicklung < als 55 dBA
- Belastung 0 - 75 kg, optional 40 - 115 kg
- Softstart, Softstop

**Motorverstellung M2**

- optional Komfortsteuerung mit Höhenanzeige und 4 Memory-Positionen

**Verstellarten / type of adjustment:**

Verstellung / adjustment	Belastung / weight bearing
H2 Hand mit Gewichtsausgleich / hand, with weight compensation	0 - 40 kg
M1 Motor, Einfachsteuerung / motor, up and down	0 - 75 kg
M2 Motor, Komfortsteuerung / motor, with memory function	0 - 75 kg

**Option Zusatzgewichte / option additional weight:**

	standard	Z1	Z2	Z3	Z4	ZM
H2	0 - 40 kg			20 - 60 kg	40 - 80 kg	
M1	0 - 75 kg					40 - 115 kg
M2	0 - 75 kg					40 - 115 kg

**height adjustment by hand H2**

- with weight compensation for different imposed loads
- 3 weight classes: 0 - 40, 20 - 60, 40 - 80 kg
- continuously locking
- weight load up to 120 kg in fixed position

**height adjustment by motor M1**

- quiet motor integrated in the frame
- speed of adjustability: approx 70 mm/s
- noise development less than 55 dBA
- weight bearing 0 - 75 kg, option 40 - 115 kg
- softstart, softstop

**height adjustment by motor M2**

- option: comfort control including LED display and 4 memory positions

Übersicht Positionen Kabeldurchlassdosen, Kabelschächte und Organisationsbohrungen

survey of cable outlet, cable ducts and organisation holes

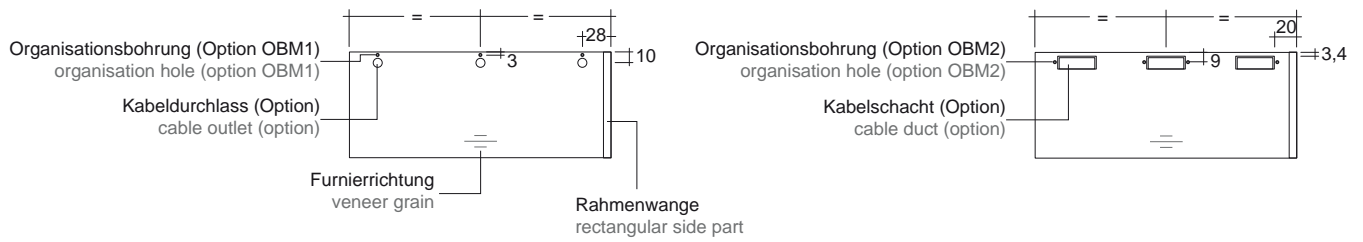

**Übersicht Position der Organisationsbohrungen und Kabeldurchlässe**

(In Verbindung mit Kabeldurchlässen bitte die Organisationsbohrungen Option OBM1 bestellen.)

**Survey of organisation holes and cable outlets**

(In combination with cable outlets please order organisation holes option OBM1.)

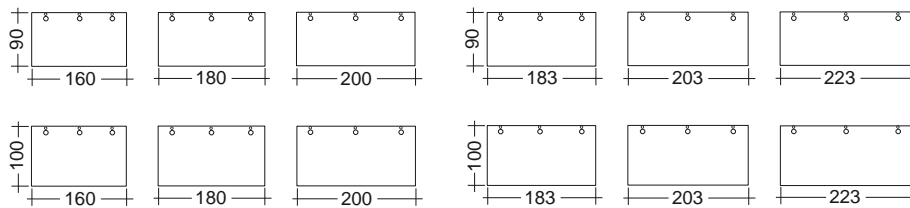

**Übersicht Position der Organisationsbohrungen und Kabelschächte**

(In Verbindung mit Kabelschächten bitte die Organisationsbohrungen Option OBM2 bestellen.)

**Survey of organisation holes and cable ducts**

(In combination with cable ducts please order organisation holes option OBM2.)

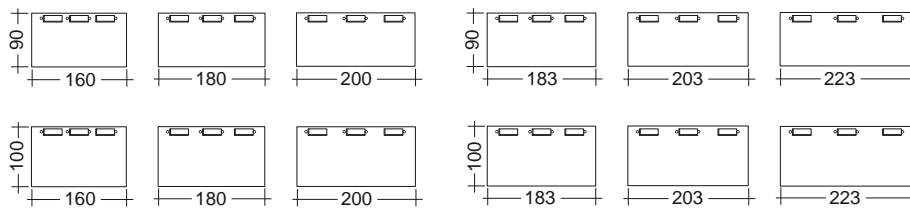

**Kabelschächte siehe separate Preisliste "Systemverkabelung"!**

Cable ducts see separate price list "Electrical Accessories"!



Verstellart / adjustment:

H2: Hand mit Gewichtsausgleich / hand, with weight compensation  
M1: Motor, Einfachsteuerung / motor, up and down  
M2: Motor, Komfortsteuerung / motor, with memory function

Belastung / weight bearing:

H2: 0 - 40 kg  
M1: 0 - 75 kg  
M2: 0 - 75 kg

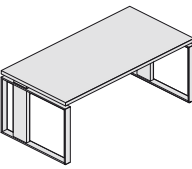
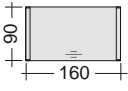
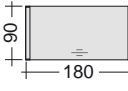
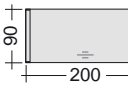
Arbeitsstische, 90 cm tief		work stations, 90 cm deep					
	Trägermaterial: Oberfläche:	Spanplatte (28) Melamin	Spanplatte (28) Echtholz	Tipla (38) Melamin	Tipla (38) Echtholz	Säulenprofile Alu gebürstet farblos eloxiert* 075	Rahmen- wangen hochglanz- chrom 057
	basic material: surface:	chipboard (28) melamine	chipboard (28) real wood veneer	blockboard (38) melamine	blockboard (38) real wood veneer	columns alu brushed clear anodised* 075	rectangular side parts mirror finish 057
		<b>SM</b>	<b>SF</b>	<b>TM</b>	<b>TF</b>		
	<b>IMF2TR1-16-H2- **</b>						
	<b>IMF2TR1-16-M1- **</b>						
	<b>IMF2TR1-16-M2- **</b>						
	<b>IMF2TR1-18-H2- **</b>						
	<b>IMF2TR1-18-M1- **</b>						
	<b>IMF2TR1-18-M2- **</b>						
	<b>IMF2TR1-20-H2- **</b>						
	<b>IMF2TR1-20-M1- **</b>						
	<b>IMF2TR1-20-M2- **</b>						
Notw. Farbangaben: Nec. colour details:	1. Gestell / frame 2. Rahmenwangen / r. side part	3. Platte / top				1. Gestell frame	2. Rahmen- wangen r. side part

Weitere Optionen		further options	
Option	Beschreibung	description	Preis / price
<b>-K2L/-K2R/-K2M</b>	Kabeldurchlass aus Metall links, rechts, mittig	cable outlet made of metal left, right, central position	à
Notwendige Farbangabe / Necessary colour detail:		<b>4. Kabeldurchlass / cable outlet</b>	
<b>-KSL/-KSR/-KSM</b>	Ausschnitt für Kabelschacht links, rechts, mittig	cutout for cable duct left, right, central position	à
<b>-OBM1</b>	Organisationsbohrungen i.V. mit Kabeldurchlässen	organisation holes (with cable outlets)	
<b>-OBM2</b>	Organisationsbohrungen i.V. mit Kabelschächten	organisation holes (with cable ducts)	
<b>-Z3</b>	höheres Zusatzgewicht für H2 (20-60 kg)	higher additional weight for H2 (20-60 kg)	
<b>-Z4</b>	höheres Zusatzgewicht für H2 (40-80 kg)	higher additional weight for H2 (40-80 kg)	---
<b>-ZM</b>	höheres Zusatzgewicht für M1 und M2 (40-115 kg)	higher additional weight for M1 and M2 (40-115 kg)	---

- Kabelschächte sind nur in Verbindung mit der Kabelwanne Typ 2 (für die gesamte Tischbreite) sinnvoll!
- cable ducts are only in connection with the cable tray type 2 entire width of desk).

Übersicht Position Kabelschacht siehe Kapitel 02, Kabelschächte siehe separate Preisliste "Systemverkabelung"  
Survey of cable duct positions see chapter 02, cable duct see separate price list "Electrical Accessories"!

\* Option -FO2: Säulenprofil Aluminium gebürstet farblos eloxiert 075, Gestell silber metallic 029  
\* option -FO2: columns aluminium brushed clear anodised 075, frame silver metallic 029

Verstellart / adjustment:

H2: Hand mit Gewichtsausgleich / hand, with weight compensation

M1: Motor, Einfachsteuerung / motor, up and down

M2: Motor, Komfortsteuerung / motor, with memory function

Belastung / weight bearing:

H2: 0 - 40 kg

M1: 0 - 75 kg

M2: 0 - 75 kg

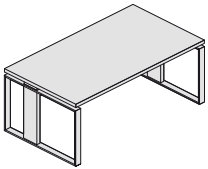
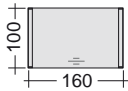
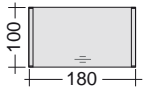
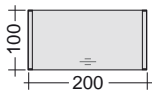
Arbeitstische, 100 cm tief		work stations, 100 cm deep							
	Trägermaterial: Oberfläche:	Spanplatte (28) Melamin	Spanplatte (28) Echtholz	Tipla (38) Melamin	Tipla (38) Echtholz	Säulenprofile Alu gebürstet farblos eloxiert* 075	Rahmen- wangen hochglanz- chrom 057		
	basic material: surface:	chipboard (28) melamine	chipboard (28) real wood veneer	blockboard (38) melamine	blockboard (38) real wood veneer	columns alu brushed clear anodised* 075	rectangular side parts mirror finish 057		
		<b>SM</b>	<b>SF</b>	<b>TM</b>	<b>TF</b>				
	<b>IMF2TR2-16-H2-</b> **								
	<b>IMF2TR2-16-M1-</b> **								
	<b>IMF2TR2-16-M2-</b> **								
	<b>IMF2TR2-18-H2-</b> **								
	<b>IMF2TR2-18-M1-</b> **								
	<b>IMF2TR2-18-M2-</b> **								
	<b>IMF2TR2-20-H2-</b> **								
	<b>IMF2TR2-20-M1-</b> **								
	<b>IMF2TR2-20-M2-</b> **								
Notw. Farbangaben: Nec. colour details:	1. Gestell / frame 2. Rahmenwangen / r. side part	3. Platte / top				1. Gestell frame	2. Rahmen- wangen r. side part		

Weitere Optionen		further options	
Option	Beschreibung	description	Preis / price
-K2L/-K2R/-K2M	Kabeldurchlass aus Metall links, rechts, mittig	cable outlet made of metal left, right, central position	à
Notwendige Farbangabe / Necessary colour detail:		4. Kabeldurchlass / cable outlet	
-KSL/-KSR/-KSM	Ausschnitt für Kabelschacht links, rechts, mittig	cutout for cable duct left, right, central position	à
-OBM1	Organisationsbohrungen i.V. mit Kabeldurchlässen	organisation holes (with cable outlets)	
-OBM2	Organisationsbohrungen i.V. mit Kabelschächten	organisation holes (with cable ducts)	
-Z3	höheres Zusatzgewicht für H2 (20-60 kg)	higher additional weight for H2 (20-60 kg)	
-Z4	höheres Zusatzgewicht für H2 (40-80 kg)	higher additional weight for H2 (40-80 kg)	
-ZM	höheres Zusatzgewicht für M1 und M2 (40-115 kg)	higher additional weight for M1 and M2 (40-115 kg)	---

• Kabelschächte sind nur in Verbindung mit der Kabelwanne Typ 2 (für die gesamte Tischbreite) sinnvoll!

• cable ducts are only in connection with the cable tray type 2 entire width of desk).

Übersicht Position Kabelschacht siehe Kapitel 02, Kabelschächte siehe separate Preisliste "Systemverkabelung"!  
Survey of cable duct positions see chapter 02, cable duct see separate price list "Electrical Accessories"!

\* Option -FO2: Säulenprofil Aluminium gebürstet farblos eloxiert 075, Gestell silber metallic 029

\* option -FO2: columns aluminium brushed clear anodised 075, frame silver metallic 029

Verstellart / adjustment:

H2: Hand mit Gewichtsausgleich / hand, with weight compensation

M1: Motor, Einfachsteuerung / motor, up and down



M2: Motor, Komfortsteuerung / motor, with memory function

Belastung / weight bearing:

H2: 0 - 40 kg

M1: 0 - 75 kg

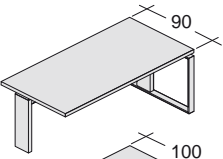
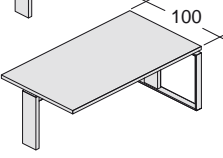
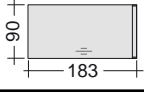
M2: 0 - 75 kg

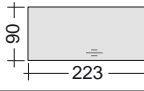
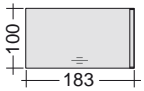
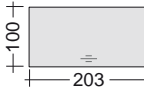
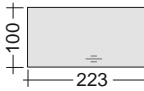
Arbeitsstische für Korpusunterbau links		work stations for pedestal or lowboard left side					
 	Trägermaterial: Oberfläche:	Spanplatte (28) Melamin	Spanplatte (28) Echtholz	Tipla (38) Melamin	Tipla (38) Echtholz	Säulenprofile Alu gebürstet farblos eloxiert* 075	Rahmen- wange hochglanz- chrom 057
	basic material: surface:	chipboard (28) melamine	chipboard (28) real wood veneer	blockboard (38) melamine	blockboard (38) real wood veneer	columns aluminium brushed clear anodised* 075	rectangular side parts mirror finish 057
		SM	SF	TM	TF		
	IMFLTR1-18-H2- **						
	IMFLTR1-18-M1- **						
	IMFLTR1-18-M2- **						
	IMFLTR1-20-H2- **						
	IMFLTR1-20-M1- **						
	IMFLTR1-20-M2- **						
	IMFLTR1-22-H2- **						
	IMFLTR1-22-M1- **						
	IMFLTR1-22-M2- **						
	IMFLTR2-18-H2- **						
	IMFLTR2-18-M1- **						
	IMFLTR2-18-M2- **						
	IMFLTR2-20-H2- **						
	IMFLTR2-20-M1- **						
	IMFLTR2-20-M2- **						
	IMFLTR2-22-H2- **						
	IMFLTR2-22-M1- **						
	IMFLTR2-22-M2- **						
Notw. Farbangaben: Nec. colour details:	1. Gestell / frame  2. Rahmenwange / r. side part	3. Platte / top				1. Gestell frame	2. Rahmen- wange r. side part

Weitere Optionen		further options	
Option	Beschreibung	description	Preis / price
-K2L/-K2R/-K2M	Kabeldurchlass aus Metall links, rechts, mittig	cable outlet made of metal left, right, central position	à
Notwendige Farbangabe / Necessary colour detail:		4. Kabeldurchlass / cable outlet	
-KSL/-KSR/-KSM	Ausschnitt für Kabelschacht links, rechts, mittig	cutout for cable duct left, right, central position	à
-OBM1	Organisationsbohrungen i.V. mit Kabeldurchlässen	organisation holes (with cable outlets)	
-OBM2	Organisationsbohrungen i.V. mit Kabelschächten	organisation holes (with cable ducts)	
-Z3	höheres Zusatzgewicht für H2 (20-60 kg)	higher additional weight for H2 (20-60 kg)	
-Z4	höheres Zusatzgewicht für H2 (40-80 kg)	higher additional weight for H2 (40-80 kg)	
-ZM	höheres Zusatzgewicht für M1 und M2 (40-115 kg)	higher additional weight for M1 and M2 (40-115 kg)	---

- Kabelschächte sind nur in Verbindung mit der Kabelwanne Typ 2 (für die gesamte Tischbreite) sinnvoll!
- cable ducts are only in connection with the cable tray type 2 entire width of desk).

Übersicht Position Kabelschacht siehe Kapitel 02, Kabelschächte siehe separate Preisliste "Systemverkabelung"  
Survey of cable duct positions see chapter 02, cable duct see separate price list "Electrical Accessories"!

\* Option -FO2: Säulenprofil Aluminium gebürstet farblos eloxiert 075, Gestell silber metallic 029

\* option -FO2: columns aluminium brushed clear anodised 075, frame silver metallic 029

**Verstellart / adjustment:**

H2: Hand mit Gewichtsausgleich / hand, with weight compensation

M1: Motor, Einfachsteuerung / motor, up and down





M2: Motor, Komfortsteuerung / motor, with memory function

**Belastung / weight bearing:**

H2: 0 - 40 kg

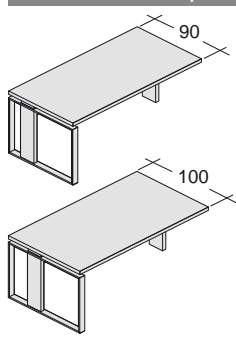
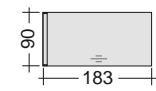
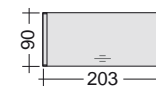
M1: 0 - 75 kg

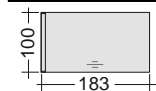
M2: 0 - 75 kg

Arbeitstische für Korpusunterbau rechts		work stations for pedestal or lowboard right side					
	<b>Trägermaterial:</b> <b>Oberfläche:</b>	Spanplatte (28) Melamin	Spanplatte (28) Echtholz	Tipla (38) Melamin	Tipla (38) Echtholz	Säulenprofile Alu gebürstet farblos eloxiert* 075	Rahmen- wange hochglanz- chrom 057
	<b>basic material:</b> <b>surface:</b>	chipboard (28) melamine	chipboard (28) real wood veneer	blockboard (38) melamine	blockboard (38) real wood veneer	columns aluminium brushed clear anodised* 075	rectangular side parts mirror finish 057
		<b>SM</b>	<b>SF</b>	<b>TM</b>	<b>TF</b>		
	<b>IMFRTR1-18-H2- **</b>						
	<b>IMFRTR1-18-M1- **</b>						
	<b>IMFRTR1-18-M2- **</b>						
	<b>IMFRTR1-20-H2- **</b>						
	<b>IMFRTR1-20-M1- **</b>						
	<b>IMFRTR1-20-M2- **</b>						
	<b>IMFRTR1-22-H2- **</b>						
	<b>IMFRTR1-22-M1- **</b>						
	<b>IMFRTR1-22-M2- **</b>						
	<b>IMFRTR2-18-H2- **</b>						
	<b>IMFRTR2-18-M1- **</b>						
	<b>IMFRTR2-18-M2- **</b>						
	<b>IMFRTR2-20-H2- **</b>						
	<b>IMFRTR2-20-M1- **</b>						
	<b>IMFRTR2-20-M2- **</b>						
	<b>IMFRTR2-22-H2- **</b>						
	<b>IMFRTR2-22-M1- **</b>						
	<b>IMFRTR2-22-M2- **</b>						
<b>Notw. Farbangaben:</b> <b>Nec. colour details:</b>	<b>1. Gestell / frame</b>  <b>2. Rahmenwange / r. side part</b>	<b>3. Platte / top</b>				<b>1. Gestell</b> <b>frame</b>	<b>2. Rahmen- wange</b> <b>r. side part</b>

Weitere Optionen			further options
Option	Beschreibung	description	Preis / price
<b>-K2L/-K2R/-K2M</b>	Kabeldurchlass aus Metall links, rechts, mittig	cable outlet made of metal left, right, central position	à
<b>Notwendige Farbangabe / Necessary colour detail:</b>			<b>4. Kabeldurchlass / cable outlet</b>
<b>-KSL/-KSR/-KSM</b>	Ausschnitt für Kabelschacht links, rechts, mittig	cutout for cable duct left, right, central position	à
<b>-OBM1</b>	Organisationsbohrungen i.V. mit Kabeldurchlässen	organisation holes (with cable outlets)	
<b>-OBM2</b>	Organisationsbohrungen i.V. mit Kabelschächten	organisation holes (with cable ducts)	
<b>-Z3</b>	höheres Zusatzgewicht für H2 (20-60 kg)	higher additional weight for H2 (20-60 kg)	
<b>-Z4</b>	höheres Zusatzgewicht für H2 (40-80 kg)	higher additional weight for H2 (40-80 kg)	---
<b>-ZM</b>	höheres Zusatzgewicht für M1 und M2 (40-115 kg)	higher additional weight for M1 and M2 (40-115 kg)	---

• Kabelschächte sind nur in Verbindung mit der Kabelwanne Typ 2 (für die gesamte Tischbreite) sinnvoll!





• cable ducts are only in connection with the cable tray type 2 (entire width of desk).

Übersicht Position Kabelschacht siehe Kapitel 02, Kabelschächte siehe separate Preisliste "Systemverkabelung"!  
 Survey of cable duct positions see chapter 02, cable duct see separate price list "Electrical Accessories"!

\* Option -FO2: Säulenprofil Aluminium gebürstet farblos eloxiert 075, Gestell silber metallic 029

\* option -FO2: columns aluminium brushed clear anodised 075, frame silver metallic 029

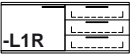

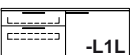
Lowboard, 170 cm breit			lowboard, 170 cm wide				
inkl. Griff -GM/-GN eine Materialschale (Schubfach) Holz-Einlegeboden hinter Flügelür Stellschrauben	1 Frontblock	<b>Kombination 1</b> Melamin	<b>Kombination 2</b> Echtholz	<b>Kombination 3</b> Melamin	komplett verschieß- bar	Griff- option	
	1 Frontblock	Melamin	Echtholz oder Melamin lackiert	Echtholz oder Melamin lackiert			
inclusive handle -GM/-GN one pencil tray (drawer) wooden-shelf behind hinged doors adjusting screws	1 front unit	<b>combination 1</b> melamine	<b>combination 2</b> real wood veneer	<b>combination 3</b> melamine	completely lockable	option handle	
	1 front unit	melamine	real wood veneer or melamine lacquered	real wood veneer or melamine lacquered			
<b>Verstellart Arbeitstisch* / work station adjustment*</b>		<b>FK1</b>	<b>FK2</b>	<b>FK3</b>			
	<b>IML1R-01- B -***</b>				-VSK	-GK ---	
	<b>IML1L-01- B -***</b>						
	<b>IML1R-02- B -***</b>				-VSK	-GK ---	
	<b>IML1L-02- B -***</b>						
	<b>IML1R-03- B -***</b>				-VSK	-GK ---	
	<b>IML1L-03- B -***</b>						
<b>Notwendige Farbangaben:</b> Necessary colour detail:	<b>1. Korpus / carcass</b>	<b>2. Frontblock links / front unit left</b>		<b>4. Kabelkettendurchlass</b> cable chain outlet			
		<b>3. Frontblock rechts / front unit right</b>		<b>5. Kabelkette / cable chain</b>			



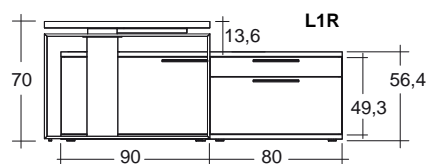
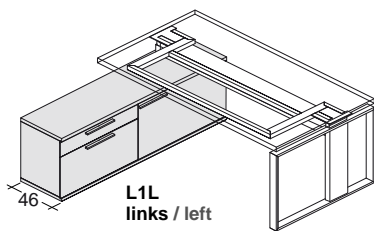

Weitere Option		further option	
Option	Beschreibung	description	Preis / price
-AF	Abdeckplatte Echtholz	top real wood	
<b>Notwendige Farbangaben / Necessary colour details:</b>			<b>6. Abdeckplatte / top</b>

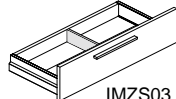
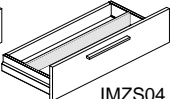
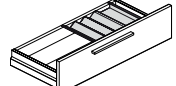

- mit Kabelkettendurchlass und Kabelkette von der Tischplatte in den Korpus
- mit Sichrückwand, 19 mm, in Korpusfarbe
- with cable chain outlet and cable chain from the desk top to the carcass
- with decorative back panel, 19 mm, colour same as carcass

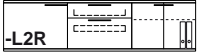
Zubehör für Organisationsschubfächer		accessories for drawers	
	<b>IMZS03</b>	Facheinteilung längs / drawer partitions lengthwise	<b>IMZS03</b>
	<b>IMZS04</b>	Facheinteilung quer / drawer partitions crosswise	<b>IMZS04</b>
		Materialschale / pencil tray	<b>IMZS05</b>

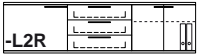
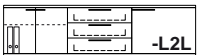
\* Verstellart Arbeitstisch: B - Höhenverstellung (H1, H2, M1, M2)  
\* work station, adjustment : B - height adjustment (H1, H2, M1, M2)

Lowboard, 250 cm breit		lowboard, 250 cm wide				
inkl. Griff -GM/-GN eine Materialschale (Schubfach) Holz-Einlegeboden hinter Flügel Tür Stellschrauben	Frontblöcke links und rechts	<b>Kombination 1</b> Melamin	<b>Kombination 2</b> Echtholz	<b>Kombination 3</b> Melamin	komplett verschieß- bar	Griff- option
	Frontblöcke Mitte	Melamin	Echtholz oder Melamin lackiert	Echtholz oder Melamin lackiert		
inclusive handle -GM/-GN one pencil tray (drawer) wooden-shelf behind hinged doors adjusting screws	front unit left and right	<b>combination 1</b> melamine	<b>combination 2</b> real wood veneer	<b>combination 3</b> melamine	completely lockable	option handle
	front unit central	melamine	real wood veneer or melamine lacquered	real wood veneer or melamine lacquered		
Verstellart Arbeitstisch* / work station adjustment*		<b>FK1</b>	<b>FK2</b>	<b>FK3</b>		
	<b>IML2R-01- B -***</b>				-VSK	
	<b>IML2L-01- B -***</b>					
	<b>IML2R-02- B -***</b>				-VSK	
	<b>IML2L-02- B -***</b>					
	<b>IML2R-03- B -***</b>				-VSK	
	<b>IML2L-03- B -***</b>					
Notwendige Farbangaben: Necessary colour detail:	1. Korpus / carcass	2. Frontblock links und rechts / front unit left and right 3. Frontblock Mitte / front unit central			4. Kabelkettendurchlass cable chain outlet 5. Kabelkette / cable chain	

Weitere Option		further option	
Option	Beschreibung	description	Preis / price
-AF	Abdeckplatte Echtholz	top real wood	
Notwendige Farbangaben / Necessary colour details:			6. Abdeckplatte / top

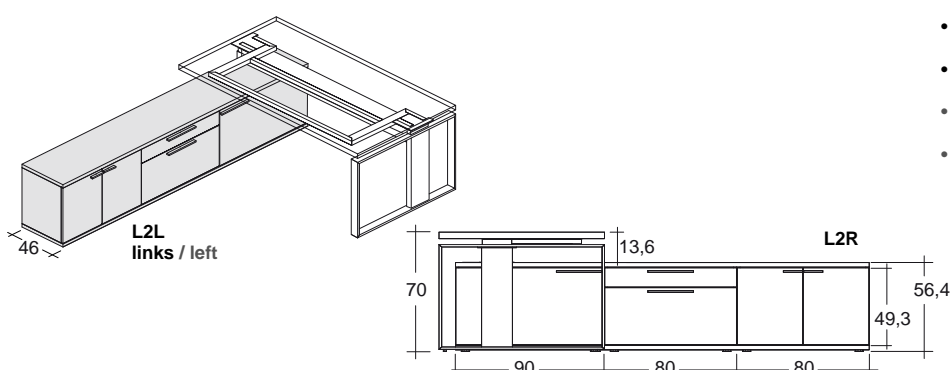

- mit Kabelkettendurchlass und Kabelkette von der Tischplatte in den Korpus
- mit Sichrückwand, 19 mm, in Korpusfarbe
- with cable chain outlet and cable chain from the desk top to the carcass
- with decorative back panel, 19 mm, colour same as carcass

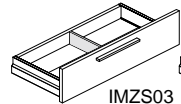
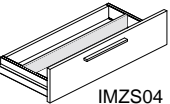
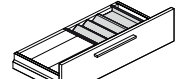
Zubehör für Organisationsschubfächer		accessories for drawers	
		Facheinteilung längs / drawer partitions lengthwise	<b>IMZS03</b>
		Facheinteilung quer / drawer partitions crosswise	<b>IMZS04</b>
		Materialschale / pencil tray	<b>IMZS05</b>

\* Verstellart Arbeitstisch: B - Höhenverstellung (H1, H2, M1, M2)  
\* work station, adjustment : B - height adjustment (H1, H2, M1, M2)

Technikcontainer		pedestals for files and hardware					
		Abdeckplatte und Blenden: blinds and top:	Melamin melamine	Echtholz real wood veneer	Für -M1: Abdeckpl./Blenden in 070, 071 For -M1: top/blinds in 070, 071	CPU-Fach verschießbar  CPU drawer lockable	
Verstellart Arbeitstisch* / work station adjustment*			M1	F1			
		IMTC2R-1233- B -**					
		IMTC2L-1233- B -**					
		IMTC2R-126- B -**					
		IMTC2L-126- B -**					
<b>Notwendige Farbangaben:</b> Necessary colour details:		1. Korpus / carcass	2. Abdeckplatte und Blenden / top and blinds		2. Oberfläche Abdeckpl./Blenden top/blinds		
			3. Kabelkettendurchlass / cable chain outlet		4. Kabelkette / cable chain		

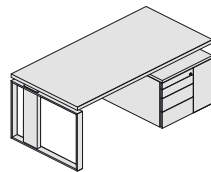
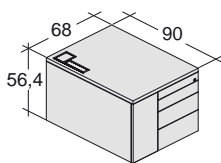

rechts (R)  
right (R)

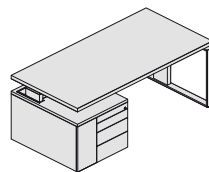



links (L)  
left (L)

- mit Kabelkettendurchlass und Kabelkette von der Tischplatte in den Korpus
- alle Fächer mit Einschubdämpfung
- Fach 1 voll ausziehbar
- alle anderen Fächer mit Vollauszug (Überauszug), Belastbarkeit bis 45 kg, Kippsicherheit bis 36 kg
- Inneneinteilung siehe separate Preisliste "desk add"
- Schubfächer immer verschließbar  
CPU-Fach optional verschließbar
- incl. cable chain outlet and cable chain running from the desk top to the carcass
- all drawers with damped closing
- drawer 1 with 100% opening
- all other drawers with >100% opening, load bearing capacity -45 kg, tilting prevention -36 kg
- accessories see separate price list "desk add"
- drawers always lockable  
CPU drawer optional lockable

\* Verstellart Arbeitstisch: B - Höhenverstellung (H1, H2, M1, M2)  
\* work station, adjustment : B - height adjustment (H1, H2, M1, M2)

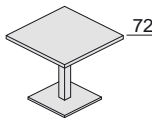

Besprechungstische quadratisch, starr		square conference desks, fixed height					
		Trägermaterial: Oberfläche:	Spanplatte (28) Melamin	Spanplatte (28) Echtholz	Tipla (38) Melamin	Tipla (38) Echtholz	Farboption 077 (passend zu 057)
		basic material: surface:	chipboard (28) melamine	chipboard (28) real wood veneer	blockboard (38) melamine	blockboard (38) real wood veneer	colour 077 (matches with 057)
			SM	SF	TM	TF	
							
	IMFBTQ-08-ST- **						-FO5
	IMFBTQ-09-ST- **						-FO5
Notw. Farbangaben: Nec. colour details:	1. Gestell / frame	3. Platte / top				2. Fußplatte foot plate	
	2. Fußplatte / foot plate						

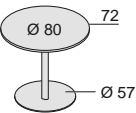
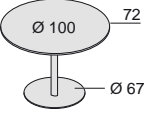
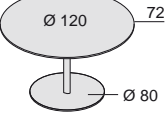
Besprechungstische rund, starr		round conference desks, fixed height					
		Trägermaterial: Oberfläche:	Spanplatte (28) Melamin	Spanplatte (28) Echtholz	Tipla (38) Melamin	Tipla (38) Echtholz	Farboption 077 (passend zu 057)
		basic material: surface:	chipboard (28) melamine	chipboard (28) real wood veneer	blockboard (38) melamine	blockboard (38) real wood veneer	colour 077 (matches with 057)
			SM	SF	TM	TF	
							
	IMFBR3-08- **						-FO5
							
	IMFBR3-10- **						-FO5
							
	IMFBR3-12- **						-FO5
Notw. Farbangaben: Nec. colour details:	1. Gestell / frame	3. Platte / top				2. Fußplatte foot plate	
	2. Fußplatte / foot plate						

Verstellart / adjustment:

ST: starr / fixed height

H2: Hand mit Gewichtsausgleich / hand, with weight compensation

M1: Motor, Einfachsteuerung / motor, up and down

M2: Motor, Komfortsteuerung / motor, with memory function

Belastung / weight bearing:

H2: 0 - 40 kg

M1: 0 - 75 kg

M2: 0 - 75 kg

Besprechungstische rechteckig, höhenverstellbar rectangular conference desks, height adjustable

	Trägermaterial: Oberfläche: Ausgangshöhe ca:	Spanplatte (28) Melamin 74 cm	Spanplatte (28) Echtholz 74 cm	Tipla (38) Melamin 74 cm	Tipla (38) Echtholz 74 cm	Säulenprofile Alu gebürstet farblos eloxiert* 075	Farboption 077 (passend zu 057)
	basic material: surface:	chipboard (28) melamine	chipboard (28) real wood veneer	blockboard (38) melamine	blockboard (38) real wood veneer	columns alu brushed clear anodised* 075	colour 077 (matches with 057)
		<b>SM</b>	<b>SF</b>	<b>TM</b>	<b>TF</b>		
	<b>IMFBTR-20-ST- **</b>					-FO2	-FO5
	<b>IMFBTR-20-H2- **</b>					-FO2	-FO5
	<b>IMFBTR-20-M1- **</b>					-FO2	-FO5
	<b>IMFBTR-20-M2- **</b>					-FO2	-FO5
	<b>IMFBTR-24-ST- **</b>					-FO2	-FO5
	<b>IMFBTR-24-H2- **</b>					-FO2	-FO5
	<b>IMFBTR-24-M1- **</b>					-FO2	-FO5
	<b>IMFBTR-24-M2- **</b>					-FO2	-FO5

Besprechungstische Freiform, höhenverstellbar free form conference desks, height adjustable

	Trägermaterial: Oberfläche: Ausgangshöhe ca:	Spanplatte (28) Melamin 74 cm	Spanplatte (28) Echtholz 74 cm	Tipla (38) Melamin 74 cm	Tipla (38) Echtholz 74 cm	Säulenprofile Alu gebürstet farblos eloxiert* 075	Farboption 077 (passend zu 057)
	basic material: surface:	chipboard (28) melamine	chipboard (28) real wood veneer	blockboard (38) melamine	blockboard (38) real wood veneer	columns alu brushed clear anodised* 075	colour 077 (matches with 057)
		<b>SM</b>	<b>SF</b>	<b>TM</b>	<b>TF</b>		
	<b>IMFBTF-20-ST- **</b>					-FO2	-FO5
	<b>IMFBTF-20-H2- **</b>					-FO2	-FO5
	<b>IMFBTF-20-M1- **</b>					-FO2	-FO5
	<b>IMFBTF-20-M2- **</b>					-FO2	-FO5
	<b>IMFBTF-24-ST- **</b>					-FO2	-FO5
	<b>IMFBTF-24-H2- **</b>					-FO2	-FO5
	<b>IMFBTF-24-M1- **</b>					-FO2	-FO5
	<b>IMFBTF-24-M2- **</b>					-FO2	-FO5

Notw. Farbangaben:	<b>1. Gestell / frame</b>	<b>3. Platte / top</b>	<b>1. Gestell</b>	<b>2. Fußplatte</b>
Nec. colour details:			frame	foot plate
	<b>2. Fußplatte / foot plate</b>			

Weitere Optionen further options

Option	Beschreibung	description	Preis / price
-TB1	Ausschnitt für Turnbox (1x), Position 1	cutout for turnbox (1x), position 1	
-TB2	Ausschnitt für Turnbox (2x), Position 2, nur für Tischbreite 240 cm	cutout for turnbox (2x), position 2, only for desk width 240 cm	
-KS1	Ausschnitt für Kabelschacht (1x), Position 1	cutout for cable duct (1x), position 1	
-KS2	Ausschnitt f. Kabelschacht (2x), Pos. 2, nur für Tischbreite 240 cm	cutout for cable duct (2x), pos. 2, only for desk width 240 cm	
-Z3	höheres Zusatzgewicht für H2 (20-60 kg)	higher additional weight for H2 (20-60 kg)	
-Z4	höheres Zusatzgewicht für H2 (40-80 kg)	higher additional weight for H2 (40-80 kg)	
-ZM	höheres Zusatzgewicht für M1 und M2 (40-115 kg)	higher additional weight for M1 and M2 (40-115 kg)	---

• Kabelwanne Typ 3, für Kabelschacht, siehe 06.01

• Kabelschächte siehe separate Preisliste "Systemverkabelung"!

• Cable tray type 3, for cable duct see 06.01

• Cable duct see separate price list "Electrical Accessories"!

\* Option -FO2: Säulenprofil Aluminium gebürstet farblos eloxiert 075, Gestell silber metallic 029

\* option -FO2: columns aluminium brushed clear anodised 075, frame silver metallic 029

Verstellart / adjustment:  
H1: Hand / hand

Belastung / weight bearing:  
H1: 0 - 15 kg

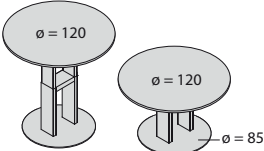
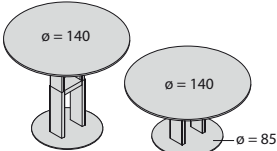
Besprechungstische rund, höhenverstellbar		round conference desks, height adjustable					
Trägermaterial: Oberfläche:	Spanplatte (28) Melamin 71 cm	Spanplatte (28) Echtholz 71 cm	Tipla (38) Melamin 71 cm	Tipla (38) Echtholz 71 cm	Säulenprofile Alu gebürstet farblos eloxiert* 075	Farboption 077 (passend zu 057)	
basic material: surface:	chipboard (28) melamine	chipboard (28) real wood veneer	blockboard (38) melamine	blockboard (38) real wood veneer	columns alu brushed clear anodised* 075	colour 077 (matches with 057)	
	SM	SF	TM	TF			
 <p>IMFBR4-12-H1- **</p>					-FO2	-FO5	
 <p>IMFBR4-14-H1- **</p>					-FO2	-FO5	
<p>Notw. Farbangaben: 1. Gestell / frame</p> <p>Nec. colour details: 2. Fußplatte / foot plate</p>	3. Platte / top			1. Gestell frame	2. Fußplatte foot plate		

\* Option -FO2: Säulenprofil Aluminium gebürstet farblos eloxiert 075, Gestell silber metallic 029  
\* option -FO2: columns aluminium brushed clear anodised 075, frame silver metallic 029





Kabelwanne, Typ 1	cable tray, type 1	
	Breite width	
	80 cm	IMKW1- 08
Notwendige Farbangaben / necessary colour details:		
	Kabelwanne / cable tray	

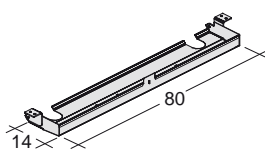
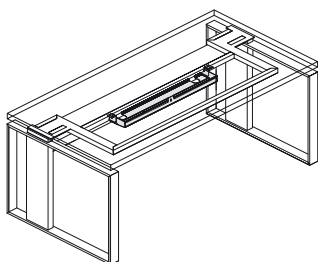

- abklappbar
- für alle Tischtypen
- Montage vor der Traverse
- inkl. 2 Einfach-Kabelbügel

- swinging downwards for easy access
- for all desks
- positioned in front of the cross rail
- incl. 2 cable bows

Kabelwanne, Typ 2	cable tray, type 2	
	für Tischbreite for desk width	Variante variant
		1 / 2 / 3
	160 cm	IMKW2- 16- 1
	180 / 183 cm	IMKW2- 18- *
	200 / 203 cm	IMKW2- 20- *
	223 cm	IMKW2- 22- *
Notwendige Farbangaben / necessary colour details:		
	Kabelwanne / cable tray	

**Varianten**

- 1: für freistehende Tische (160, 180, 200 cm breit)
- 2: für Korpusunterbau links (183, 203, 223 cm breit)
- 3: für Korpusunterbau rechts (183, 203, 223 cm breit)

**Variants**

- 1: for free-standing work stations (160, 180, 200 cm wide)
- 2: for pedestals or sideboards left side (183, 203, 223 cm wide)
- 3: for pedestals or sideboards right side (183, 203, 223 cm wide)

- in Verbindung mit Kabelschächten
- deckt die komplette Tischbreite ab
- Montage hinter der Traverse
- inkl. 2 Einfach-Kabelbügel
- keine Steckerleistenbefestigung möglich

- in combination with cable ducts
- for entire width of desk
- positioned behind the cross rail
- incl. 2 cable bows
- plug panel fixing not possible

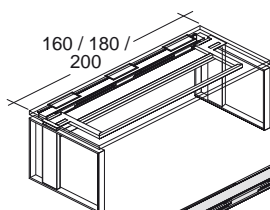

160 / 180 / 200  
Variante -1  
variant -1

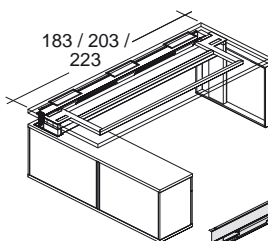

183 / 203 / 223  
Variante -2  
variant -2

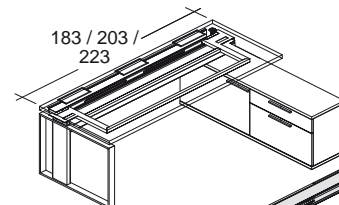

183 / 203 / 223  
Variante -3  
variant -3

Kabelwanne, Typ 3	cable tray, type 3	
	für Tischbreite / desk width	
	200 cm	IMKW3- 20
	240 cm	IMKW3- 24
Notwendige Farbangaben / necessary colour details:		
	Kabelwanne / cable tray	

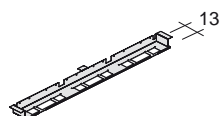
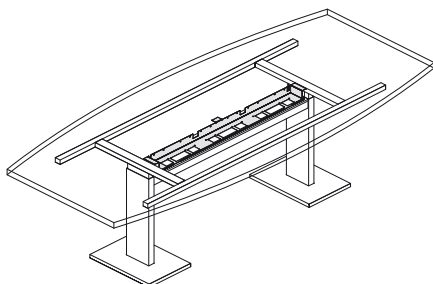

- nur für höhenverstellbare Besprechungstische
- in Verbindung mit Kabelschacht
- Montage über der Traverse

- only for height adjustable conference desks
- in combination with cable duct
- positioned above the cross rail

Weiteres Zubehör siehe separate Preisliste "Systemverkabelung"  
Further accessories see separate price list "Electrical Accessories"!

<b>Kabelkette</b>	<b>cable chain</b>
<i>mit Standfuß - vom Boden bis zur Platte / with foot - from floor to work top</i>	<b>IMKK1</b>
<i>Notwendige Farbangaben: / Necessary colour details:</i>	<ol style="list-style-type: none"> <li>1. Kabelkette / cable chain</li> <li>2. Standfuß / foot</li> </ol>

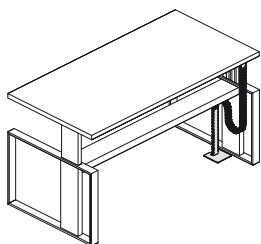

- inkl. 2 Einfach-Kabelbügel
- incl. 2 cable bows

<b>Kabelschlange</b>	<b>cable chain</b>
	<b>IMKKS</b>
<ul style="list-style-type: none"> <li>• für starre Tische</li> <li>• Montage an der Traverse</li> <li>• for work stations, fixed height</li> <li>• fixed to the cross rail</li> </ul>	
<i>Notwendige Farbangaben: / Necessary colour details:</i>	<i>Kabelschlange / cable chain</i>

<b>Kabelset</b>	<b>cabling set</b>
<i>Verkabelungsset 1 (bestehend aus Kabelwanne Typ 1, 80 cm breit, Kabelkette mit Standfuß, Steckerleiste mit Netzanschlusskabel 3 m (in schwarz) und Befestigung in der Kabelwanne)</i> <i>cabling set 1 (consisting of cable tray type 1, 80 cm wide, cable chain with foot, plug panel with mains connection cable 3 m long (in black), fixed in the cable tray)</i>	<b>IMFKSE-01</b>
<i>Notwendige Farbangaben: / Necessary colour details:</i>	<ol style="list-style-type: none"> <li>1. Kabelwanne / cable chain</li> <li>2. Kabelkette / cable chain</li> <li>3. Standfuß / foot</li> </ol>

Weiteres Zubehör siehe separate Preisliste "Systemverkabelung"!  
Further accessories see separate price list "Electrical Accessories"!

Monitorarme

monitor arms

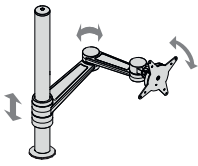

*in der Tiefe dynamisch verstellbar, Bildschirm max. 8 kg, inkl. Schnellverschluss*  
*dynamic adjustable in depth, monitor max. 8 kg, incl. quick release*

**IMZMA1**

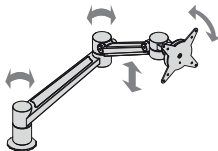

*komplett dynamisch verstellbar, Bildschirm max. 7 kg, inkl. Schnellverschluss*  
*completeley dynamic adjustable, monitor max. 7 kg, incl. quick release*

**IMZMA2**

- für eine Organisationsbohrung
- nach VESA-Standard gefertigt (75 bzw. 100 mm Interface)
- for one organisation hole
- according to VESA standard (75 or 100 mm interface)

CPU-Halter

CPU stand

**IMFZC1**

Notwendige Farbangaben / Necessary colour details:

CPU-Halter / CPU stand

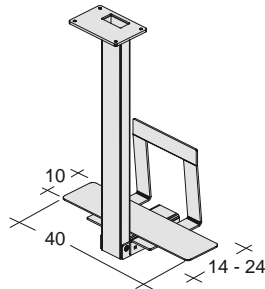
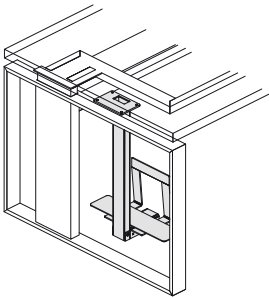

- Befestigung unterhalb der Tischplatte
- max. Nutzhöhe 52 cm
- max. Belastbarkeit 25 kg
- inkl. 2 Einfach-Kabelbügel
- fixed underneath the work top
- max. height of the CPU 52 cm
- max. load bearing capacity 25 kg
- incl. 2 cable bows

Aufsatzwand, 4 cm stark		table top screen, 4 cm thick
		Stoffgruppe: fabric:
	für Tischbreite / for desk width	
	160 cm	IMFAW- 16- 01
	180 cm	IMFAW- 18- 01
	200 cm	IMFAW- 20- 01
Notwendige Farbangaben / Necessary colour details:		Stoff / fabric

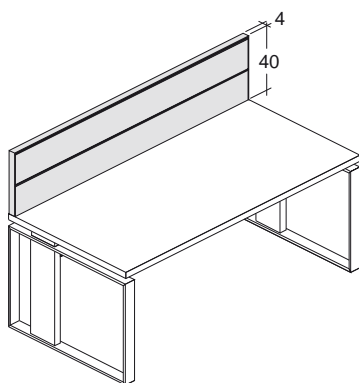



Aufsatzelemente mit hervorragenden akustischen Eigenschaften:

- Aluminiumrahmenprofil
- Füllstoff Brandklasse B1
- 100% recycelbar
- beidseitig organisierbar durch zwei waagrechte Systemschienen zum Einhängen von Zubehör
- Befestigung in zwei Organisationsbohrungen
- nicht in Verbindung mit Kabelschacht

Table top screen with excellent acoustic properties:

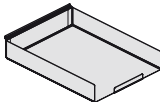
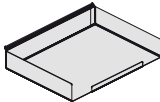
- aluminium frame
- filling material fire class B1
- 100% recyclable
- with two organisation rails on both sides for accessories
- fixing in two organisation holes
- not in combination with cable duct possible

Zubehör für die Aufsatzwand		accessories for the table top screen
	Briefablage DIN A4 längs letter storage DIN A4, lengthwise	IMAWZBL
	Briefablage DIN A4 quer letter storage DIN A4, crosswise	IMAWZBQ
	Utensilien-Ablage utensil storage	IMAWZUT
	Stiftköcher pencil box	IMAWZSK